

General Warnings

The Lowel V-light is a professional lighting fixture. Read these instructions and lamp manufacturer's warnings before operating.

- **Not for house hold use, use only** for film, video or imaging purposes.
- **Do not leave fixture unattended.**
- **Unplug fixture when not in use.**
- **V-light is available as either** a 120v model or 230v (CE approved) model. Make certain that lamp voltage matches power source voltage. *Example: never connect a 120 volt lamp to a 230 volt source.*
- **Units such as these emit** considerable light and heat, and if not properly used, could be dangerous.
- **V-light should not be positioned** extremely close to people. Ultraviolet light ray emissions can cause damage to the eyes and reddening of the skin. The likelihood of either occurring is increased with length of exposure, focus intensity and proximity. Therefore, lights should be kept away from people.
- **V-light safety glass tube must be** used to protect people and property in the unlikely event of a defective lamp exploding.
- **Avoid aiming the light at, or placing** too close to, people, delicate objects or flammable materials.
- **Do not interfere with ventilation** by covering the lights in any way.
- **For proper ventilation, do not tilt** down beyond 45 degrees or operate sideways.

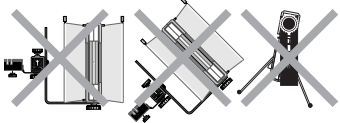

- **Lights should be operated with lamp filament horizontal.**
- **Never operate V-light with the** Mounting Bar covering the lamp (bulb).
- **Never touch hot parts only touch** handles & knobs for light adjustments.
- **Do not use near standing water.**
- **Avoid mounting lights directly over** people unless secured with a safety cord or cable.

V-light Fuse

The V-light is fused.

Fuse **A** and spare replacements **B** & **C** are located under the rear cover plate **D** of the V-light.

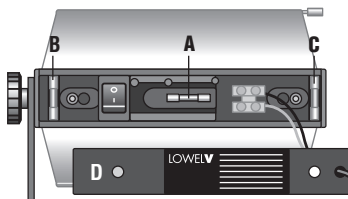

Model / Code	Volts	Fuse Amps / Volts
V1-10	120	5 / 250
V1-10CE	230	2.5 / 250

Technical Data

Size closed:
7.3 x 7.3 x 1.3",
(18.5 x 18.5 x 3.3 cm)

Weight with cable:
1.5 lbs. (680 g)

Max. wattage: 500

Max. amperage:
4.2 at 120 volts

Beam control:

door angle provides vertical beam control
Fits on: 5/8" (1.59 m) studs and accessories

Materials: primarily aluminum and Ryton

Cable:

16' (4.88 m) #18/2

Switch: in-head

U. S. Patent:
4322779

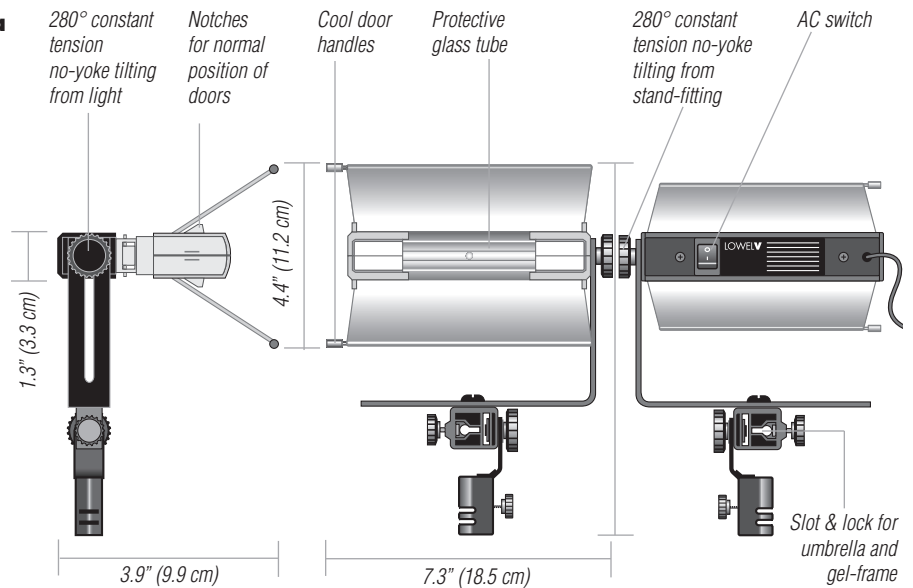

Performance

With 120v, 500w, 3150°K, GDA lamp

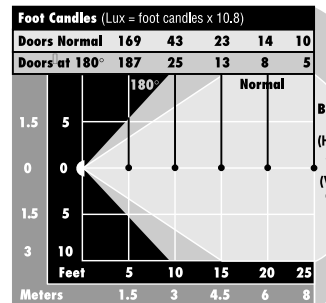

Beam angles-points at which intensity drops to 50% of maximum

V-light Operations

Loosen the large knob located on the side of the fixture, swing L-link (mounting bar) down away from lamp housing, position housing, and tighten knob, swing reflector doors open. A permanent finger grip is provided on each door to facilitate ease of handling during operation of the unit. The on/off switch is located on the rear panel of the V-light.

Warning: Lights should be operated with lamp filament horizontal.

To Store V-light

When fixture is cool to the touch. Unplug light. Fold the reflector doors back completely and swinging the bracket in front of the lamp and glass sleeve provides protection during handling and storage.

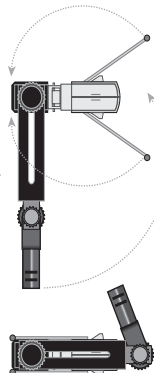

Lamp/Beam Data

Lamp Code	Volts	Watts	°K	Avg Life	F. C. (lux) at 10' (3 m)	
					doors norm	doors 180°
GDA	120	500	3150	100 hr	43 (465)	25 (270)
V1-240/250	240/250	500	3150	100 hr	37 (395)	20 (215)

The above lamps are low-pressure lamps. Tota and V lamps are not interchangeable.

V-light Door Positions

- A** Closed for storage and travel.
- B** Maximum light intensity, doors at 75°. Metal stops built into the light's housing
- C** Maximum vertical spread, doors at 180°. prevent doors from closing beyond the safe operating position.

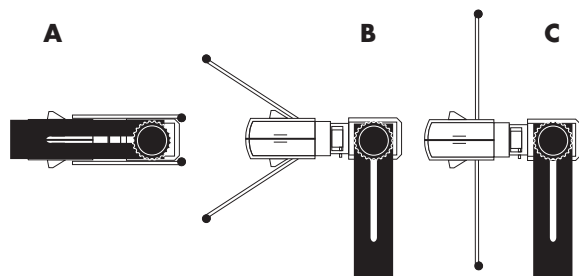

Lowel V-light Instructions

V Lamp Replacement

Warning: Always unplug unit before relamping. Lamps must be operated at their rated voltage. Only use low-pressure lamps. Fixture must be cool before relamping. Avoid touching "glass" with bare fingers. Insert lamp carefully, to avoid breaking porcelain ends. Due to inconsistencies in lamp (bulb) production, an individual lamp may function for less than rated life. Some lamp manufactures are of better quality than others and may provide longer life and better performance.

To change lamps

- 1 Flip up each porcelain socket holder **A** at the ends of the V-light and remove glass sleeve and lamp.
- 2 Insert new lamp **B** and glass sleeve **C** carefully. **To avoid possible breakage of the safety glass, close these porcelain socket holders very gently over new lamp and glass sleeve.**
- 3 Always install a new lamp with the raised glass "tip" **D** located at the center of the lamp (bulb) facing forward. Fixture will not operate without using the protective glass sleeve.

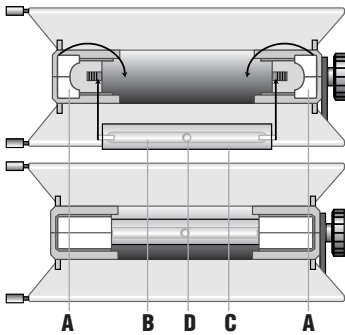

VIP Lampak

Code: ViP-61

Provides transparent, semi-rigid foam filled storage for spare lamps. Never put hot lamps in lampak.



V Light Controls

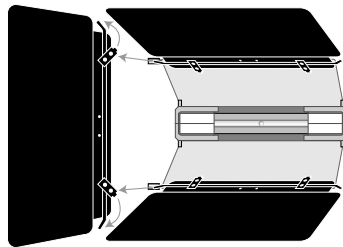

Tota-shade

Code: T1-21

Set (4)

Code: T1-24

Size: 9 x 4.5" (23 x 11.4 cm)

Add-on barndoors provide more precise control. Attach Tota-shade panels to the top and bottom reflector doors with black clips facing in. Side panels are attached by turning panel clips at 45-degree angle and attaching to bent rod ends on top and bottom doors. Tota-shade will hold 10 x 12" gel sheets even with an umbrella installed.

Universal Mounting Bracket

The V-light has a Universal Mounting Bracket (UMB) **A** located below the fixture, adjacent to the stand fitting **B**. It facilitates the mounting of V-lights and accepts several light control accessories.

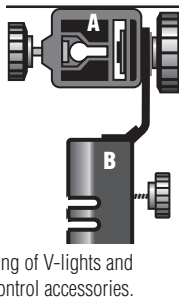

Tota-frame

Code: T1-20

Holds 10 x 12" gels. Unfold frame, extending frame bar and insert through front slot of UMB Lock with knob. Pans and tilts with the light, collapses for storage.

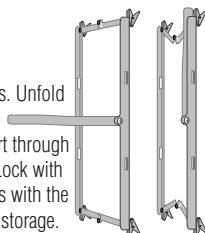

Tota/Omni Gels

Gels are secured to the frame with corner spring clips. Gels should not be doubled up. Precut, tough, fade resistant Lowel gels are available in daylight blue, frost diffusion & neutral density. Gels can be cut into various shapes to cover only part of the frame and subject. (See gel instruction sheet.)

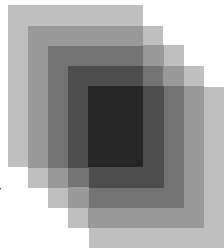

Tota-brella



Standard/Silver

Code: T1-25

Size: 27" (68.6 cm) open, 19" (48.3 cm) closed.

Special/White

Code: T1-26

Size: 27" (68.6 cm) open, 19" (48.3 cm) closed.

Photographic umbrellas convert relatively hard light sources, such as spotlights, into relatively soft sources that provide soft shadows and highlights. Although not appropriate for every subject or mood, the quality of light can be very beautiful. There are two umbrellas designed for use with the V-light, a woven, soft silver umbrella and a softer white umbrella that produces a softer light and also may be used as a large diffuser. To mount umbrella insert umbrella shaft through round hole in UMB and lock with knob. Tota-brella and Tota-frame cannot be used simultaneously. **Warning -** When lights with umbrellas are extended very high, or used on undersized stands or in areas of heavy "traffic", it is advisable to add weight (such as the Lowel weight) to the base of the stand to reduce the chance of lights falling over which could damage the umbrella, the lamp and possibly cause personal injury. **Warning -** To prevent possible umbrella damage, avoid full or near-full spot reflector settings on the Pro or i-light and do not use a Super-spot Reflector.

Flag-link

Code: ViP-50

Screws into bottom of UMB on ViP Lights; female flexi-lock accepts one Flexi-shaft.

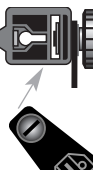

Tota-tatch

Code: T1-34

Spring clamp attaches Tota-flags and Tota-flectors with or without Flexi-shafts, to stands, pipes, and flat surfaces. The snap-in fitting rotates to help position flags. Tota-tatch may also be used to hold and position black & white cards, cue cards, gels, etc.



Tota-daptor

Code: T1-35

5/8" (116 mm) female fitting with 5/8" (16 mm) stud has 2 female flexi-locks for attaching Flexi-shafts.



Flexi-shaft (2)

Code: T1-50

A flexible arm positions Tota-flags and Tota-flectors. The fixed end of the Flexi-shaft snaps into a female connector on the Flag Link, Tota Tatch, Tota-daptor, Tota-clamp and a few other Tota components the rotating end snaps on to the flag, flector etc. Avoid overstressing connectors while bending and twisting.

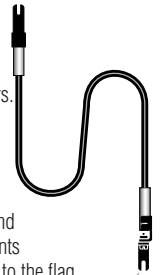

Tota-flag

Code: T1-52

8 x 12" (20 x 30 cm)

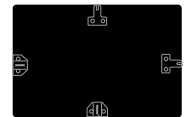

Tota-flector

Code: T1-54

8 x 12" (20 x 30 cm)

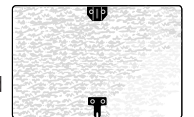

Tota flags can be used singly or snapped together end to end or side to side. Flags can be attached to the light with a flexi-shaft. Flags block or "feather" light off background, subject, or camera lens. Tota-flectors can be attached in the same way and used to redirect some of the light. It can also provide close-up fill illumination from the sun or other source over a small area. Slight convex bowing of the surface will reduce the intensity and increase the area illumination. Avoid mounting flags or reflectors directly over people unless secured with a safety cord or cable.

Constant Tension Tilting

The Universal Mounting Bracket is the standard mount of the Pro, i and V-lights. It locks onto any stand or stud up to 5/8" (16 mm). Tilting is possible with the UMB's adjustable constant-tension mechanism. The V-light, has two independent constant-tension mechanisms, one adjusted with the large knob located on the light housing **B**, the other is adjusted with the large knob located on the UMB **A**.

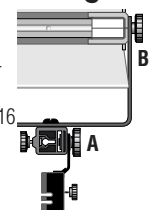

lowel 

Stands

The V-light will lock onto stands with top studs up to 5/8" (16mm). We recommend the either the Lowel Uni-stand or Uni TO Stand. Where elevation greater than nine feet is required, we recommend Lowel KS Stand with Lowel Poles or Half Poles. Lowel Weights add to stand stability and should be used when appropriate. The V-light can be suspended from beams, posts and tops of sets with the use of a Lowel Space-clamps, Lowel Grips, Interlinks, Tota-clamps or other mounting accessories.

Uni-stand

Code: UN-33

Size: 21.5" (54.6 cm) folded.

Extends to 7'11"

All aluminum stand, wide base, legs can lie flat to floor, large locking knobs.

Folds compactly to fit in smaller kits.

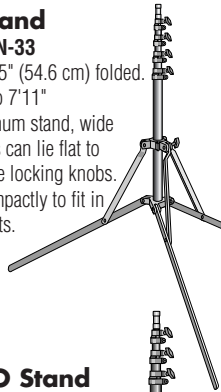

Uni TO Stand

Code: UN-55

Size: 21.5" (54.6 cm) folded.

Maximum height:

7'11" (2.4 m)

Base diameter: 43"

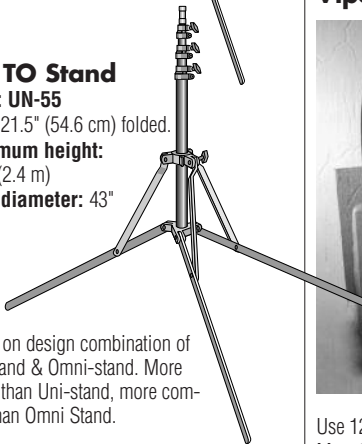

Based on design combination of Uni-stand & Omni-stand. More stable than Uni-stand, more compact than Omni Stand.

Tota-mount

Code: T1-32

Tota-mount supports any of the ViP fixtures atop doors and partitions. Doors can be open or closed. The light can be inside or outside room, since swinging arm extends past most door jambs. Tota-mount can be flipped over and nailed to studio set walls or Gaffer-taped to windows or tile, wood, metal and other wall surfaces.

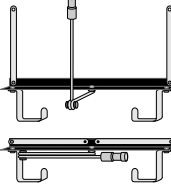

Gaffer-tape

The highest quality, cloth-backed adhesive tape attaches Lowel mounts to windows and walls.

12 yd roll Code: GT-12

Weight: 8 oz (227 g)

30 yd roll Code: GT-30

Weight: 1.25 lbs (567 g)



Mounting Tota-mount & Vipod with Gaffer Tape



Use 12" of Gaffer-tape on each bar on Tota Mount or side of Vipod and burnish down with a coin. Avoid wallpaper, soft composition board or flaking paint. Never attach to the ceiling with tape. Use original Lowel Gaffer-tape. Many substitutes leave adhesive residue or lack sufficient strength. When properly attached, Tota-mount or Vipod will support the light for days. However, on dirty or poorly bonded surfaces, or with improper or poorly applied tape, there is the danger of the mount falling down and causing serious damage. Check adhesion periodically. Prevent direct light from overheating tape. Remove tape when cool, by peeling back diagonally. Tota-mount should not be used with lights heavier than 3 lbs. (1.33 kg)

Tota-clamp

Code: T1-30

Tota-clamp supports most lights that fit standard 5/8" studs. Tota-clamp can be attached to pipes, stands, or flat surfaces. When clamping on furniture, use thin wood or cardboard to avoid marring. To rotate stud, turn wing nut counterclockwise several turns. The stud can be locked in any of four positions; two for the 5/8" stud and two for the end with the 1/4-20 tapped hole. A 1/4-20 screw can be used to lock on some microphone yokes and various accessories. Tota-clamp has two snap-in fittings for Flexi-shafts.

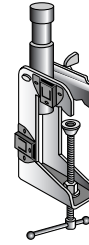

Scissor Mount

Code: CM-20

Attaches i-lights, and V-lights to dropped ceiling: Clamp X bars of grid lock to T-Bar of ceiling. Attach fixture to mount stud and tighten. Pro lights should use the Grid Lock for dropped ceiling mounting. Avoid mounting fixtures directly over people unless secured with a safety cord or cable.

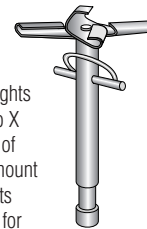

Safety Cable (3)



Code: CM-50

Size: 34" (86.4 cm)

Braided stainless-steel cable adds security to lights and accessories that are attached to overhead pipes, beams, dropped-ceiling grids, etc. (Set of 3)

For additional information on these products & more, consult product instruction sheets, relevant sections in the Lowel Catalog or visit the Stands & Mounts section of www.lowel.com

Problems, info, repairs, etc.

Lowel equipment and kits are sold through authorized Lowel Dealers and, in some countries, Authorized Lowel Distributors. Repairs, problems, suggestions, and requests for brochures, instructions, parts lists may be handled by your authorized Lowel Dealer (Distributor) or directly with Lowel. Electrical repairs should be made only by Lowel or a qualified electrician.

Lowel ViP System, Lowel V-light, and Lowel Pro-light are trademarks of Lowel-Light Manufacturing, Inc. Patent Nos. 4777566, 4322779, 0011772 (Europe), 1292007 (Japan).

Lowel V-light Instructions

V-light for the New Pro

The wide angle coverage area of the broad throw V-light makes it the ideal choice for lighting a large area evenly.

The V-light is an open face (lensless) fixture. Therefore its capable of throwing sharp shadows. The V-light's versatility are easily extended by addition of light control accessories. For example, adding a Tota-brella instantly transforms the light into a soft Key (main) light or Fill (secondary) light.

The V-light is a tungsten-halogen source. Its color temperature will be in the 3000–3200k° range, depending on lamp choice. To use V-light in locations where its output will mix with daylight (5600–6500k°), its color temperature can be converted by adding various strengths of day blue gels to the Tota-frame for more realistic white-balancing in video or film.

The V-light & Pro-light are part of the VIP system.

As a starting point, when using them together in simple setups, use Pro-light **A** for focusing on your subject, and a second Pro **B** for fill if desired. Use a V-light **C** to illuminate your back-

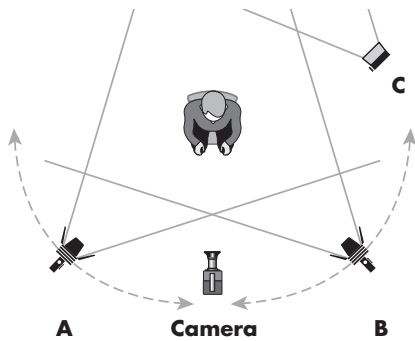

ground evenly. Position of the lights and distance to the subject can be varied for different creative results. Add diffusion gel in a Tota-frame, or attach an umbrella to create a softer source.

For soft Key & Fill in a classic interview setup, use 2 V-light's with reflective umbrellas **A** & **B** from 3/4 angles. Varying the distance of either light from the subject will vary the

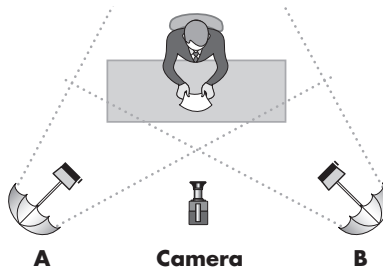

contrast ratio between Key & Fill. V-light's ability to light evenly makes it ideal for archival copy work. See Setup #2 below for further information.

Because the coverage area of the V-light is so wide, it may be necessary to trim its spill, especially to reduce risk of shadow in your shot caused by use of overhead boom microphones. Accessory Tota-shades attach quickly to the light & allow you to cut output on 2 or 4 sides. Flexi-shafts & Tota-flags can also be attached for increased light control options.

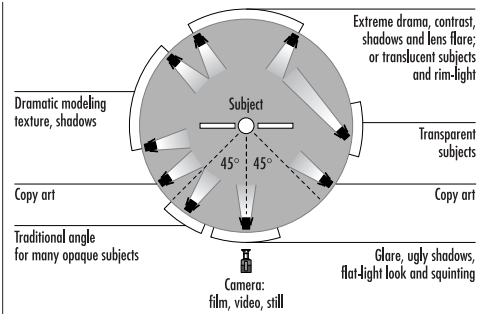

The oversimplified diagram above shows some of the ramifications of positioning lights for different subject types & lighting effects. The diagram is only useful as a starting point for new pros. All subjects & scenes are different and make different demands upon lighting. The height of the lights & camera, and the subjects angles & reflectivity must be considered.

These are just some starting suggestions.

For an in-depth understanding of the creative decisions involved in the art of lighting, we suggest Ross Lowell's acclaimed book, *Matters of Light & Depth*. Available from Lowel and many of our dealers.

Example Setups using V-light

Setup #1

To simply raise the ambient level of light in a room, point the V-light at a white wall or ceiling (from a safe distance of several feet or more). Position the light so it won't be in your shot.

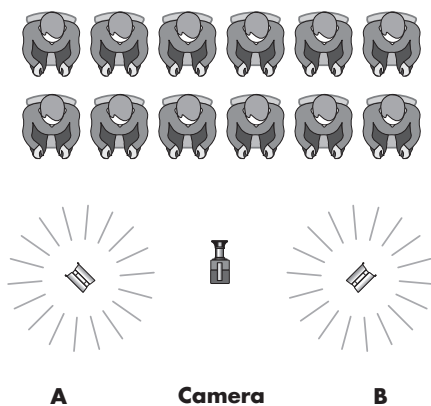

Setup #2

For archival copy work (Example: a painting hung on a wall) start by placing V-lights **A** & **B** on stands at 45° angles to the wall, on both sides of the camera. Vary the angle to the wall/camera to reduce unwanted reflection. Large subjects may require 2 V-lights at different heights on each side.

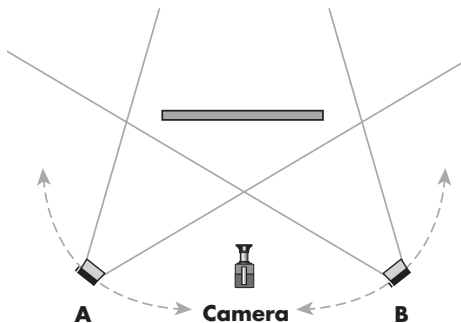

Setup #3

In classic interview setup, use 1 V-light **A** with diffusion and Tota-frame as the key light, and another V-light **B** with reflective umbrella as the softer fill light. Vary position & angle to camera for desired creative effect. **Note:** the output of the V-light key will be harder/sharper than the V-light fill because the umbrella addition creates a softer source.

Option: add a third V-light **C** to evenly light the background.

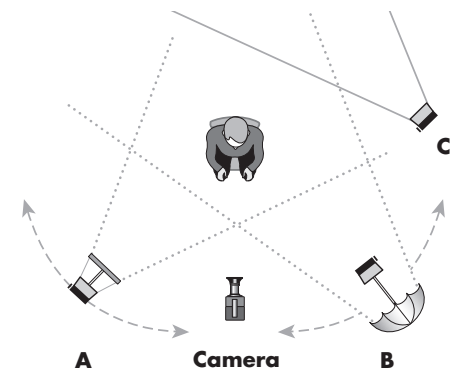

Lowel-Light Manufacturing, Inc.



90 Oser Avenue, Hauppauge, New York, 11788
Call: 800 645-2522 or 631 273-2500

e-mail: info@lowel.com
www.lowel.com



Lowel V-light Additional Warning

BE CAREFUL to gently close ceramic levers around the lamp glass tube. It is fragile and may crack. Insert the lamp so its center nipple faces forward from the fixture.



CLOSE SLOWLY

Lowel-Light Manufacturing, Inc.

90 Oser Avenue, Hauppauge, N.Y. 11788
Call: 800 645-2522 or 631 273-2500
e-mail: info@lowel.com
www.lowel.com



The Lowel V-light is a professional lighting system.

Read the V-light instructions completely, and lamp manufacturers warnings, before operating.